

# PASTFOOD

Forno elettrico modulare per pasticceria, panetteria e gastronomia

Modular electric oven for pastry, bread and gastronomy



## PASTFOOD - PFA/PFD

### CARATTERISTICHE TECNICHE

- 1 - 2 - 3 camere di cottura ( A17 o A27 ) in acciaio alluminato con piano di cottura in lamiera bugnata o in refrattario ( optional ).
- Piano di cottura e cielo con resistenze corazzate in acciaio inox
- Pannello di controllo elettromeccanico o digitale
- Controllo separato delle temperature del piano di cottura e del cielo
- Isolamento termico
- Massima temperatura di cottura 450 °C
- Valvola regolabile per scarico vapori
- Sportello con finestra in vetro temperato
- Sportelli frontali controbilanciati
- Lampade alogene ad alta resistenza e capacità luminosa
- Disponibile in acciaio inossidabile

### ACCESSORI

- Cella di lievitazione ermetica
- Supporto del forno
- Modulo cappa

### OPTIONAL

- Piano refrattario
- 4 ruote (h = 16 cm + 2 cm per la cella di lievitazione)
- Piedi per celle di lievitazione (h min = 8 cm / max = 20 cm)
- Vaporiera (assorbimento massimo 1,4 Kw)
- Kit abbattimento vapori e odori con filtro ai carboni attivi (assorbimento massimo 0,7 Kw)

### TECHNICAL SPECIFICATIONS

- 1 - 2 - 3 cooking chambers ( H17 or H27 ) in aluminium coated steel with embossed steel or refractory ( optional ) floor
- Top and bottom stainless steel armored heating elements
- Electromechanical or digital control panel
- Top and bottom separate temperature control
- Thermal insulation
- Max cook temp 450 °C
- Adjustable steam exhaust valve
- Single tempered glazed door
- Counter balanced door
- High resistance and efficiency halogen lamps
- Available stainless steel

### ACCESSORIES

- Hermetic prover compartment
- Oven support
- Hood module

### OPTIONALS

- Refractory cooking floor
- 4 wheels (h = 16 cm + 2 cm for the prover)
- Feet for provers (h min = 8 cm / max = 20 cm)
- Steam injection system (max. absorption 1,4 Kw)
- Steam and odours damper kit for hood with active carbon filter (max. absorption 0,7 Kw)

**ITALFORNI È UN BRAND  
DI WAICO GROUP**

ITALFORNI - Sede operativa  
Via dell'Industria, 130 - Loc. Chiusa di Ginestreto  
61122 Pesaro (PU) Italia - Tel. +39 0721 481515  
italforni@waicogroup.com - www.italforni.it

WAICO srl - Sede legale  
Via Scotte, 1 - Isola Vicentina  
36033 Vicenza (VI) Italia - Tel. +39 0445 1716598  
info@waicogroup.com - www.waicogroup.com

**1 CAMERA PFA + SUPPORTO ALTO**  
1 DECK PFA + HIGH STAND

✓ ALLACCIO ELETTRICO  
ELECTRIC CONNECTION

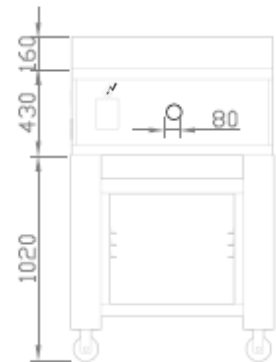
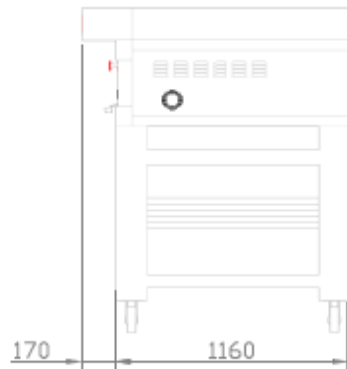
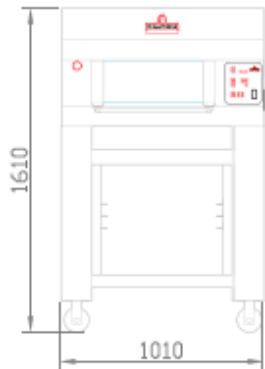

**1 CAMERA PFA + CELLA DI LIEVITAZIONE ALTA**  
1 DECK PFA + HIGH PROVER

✓ ALLACCIO ELETTRICO  
ELECTRIC CONNECTION

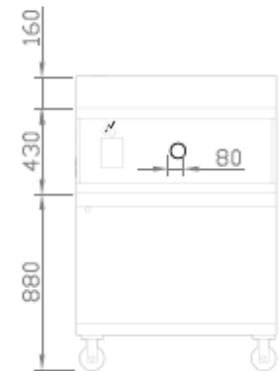
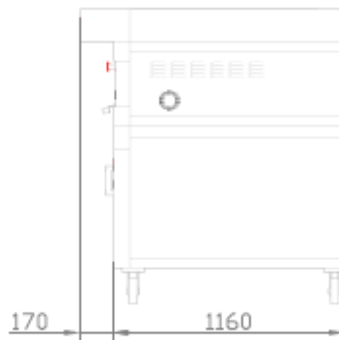
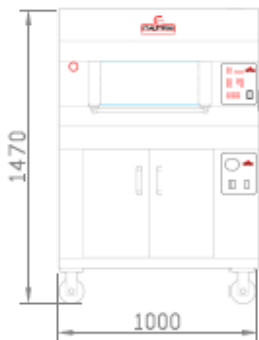

**1 CAMERA PFD + SUPPORTO ALTO**  
1 DECK PFD + HIGH STAND

✓ ALLACCIO ELETTRICO  
ELECTRIC CONNECTION

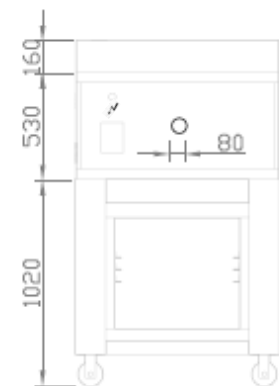
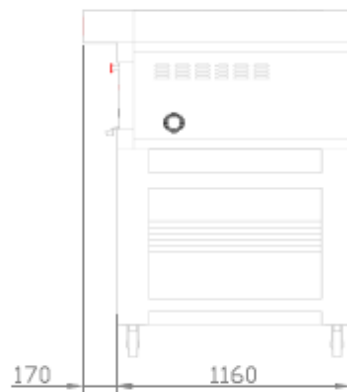
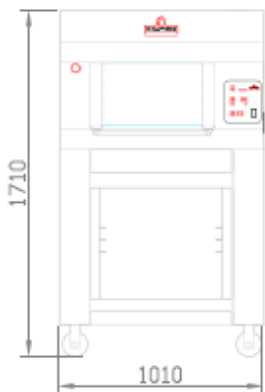

ITALFORNI È UN BRAND  
DI WAICO GROUP

ITALFORNI - Sede operativa  
Via dell'Industria, 130 - Loc. Chiusa di Ginestreto  
61122 Pesaro (PU) Italia - Tel. +39 0721 481515  
italforni@waicogroup.com - www.italforni.it

WAICO srl - Sede legale  
Via Scotte, 1 - Isola Vicentina  
36033 Vicenza (VI) Italia - Tel. +39 0445 1716598  
info@waicogroup.com - www.waicogroup.com

**1 CAMERA PFD + CELLA DI LIEVITAZIONE ALTA**  
**1 DECK PFD + HIGH PROVER**

ALLACCIO ELETTRICO  
 ELECTRIC CONNECTION

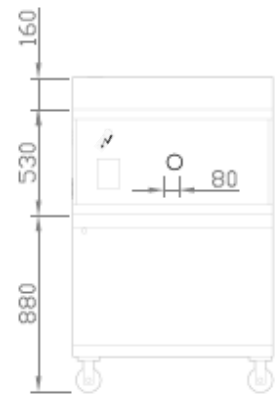
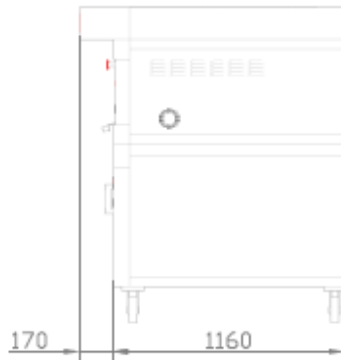
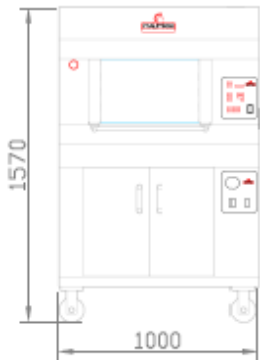

**2 CAMERE PFA + SUPPORTO MEDIO**  
**2 DECKS PFA + MID STAND**

ALLACCIO ELETTRICO  
 ELECTRIC CONNECTION

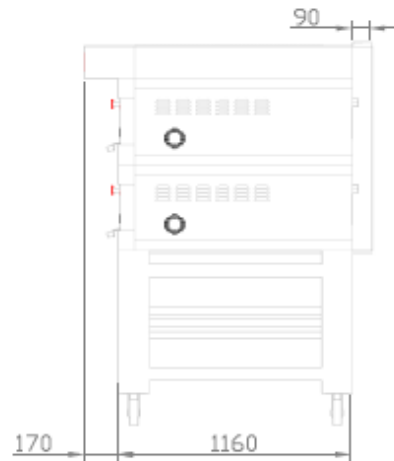
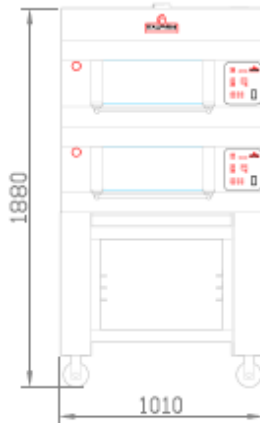

**2 CAMERE PFA + CELLA DI LIEVITAZIONE ALTA**  
**2 DECKS PFA + HIGH PROVER**

ALLACCIO ELETTRICO  
 ELECTRIC CONNECTION

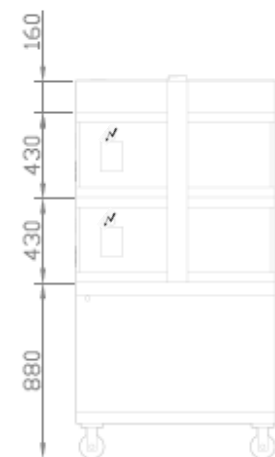
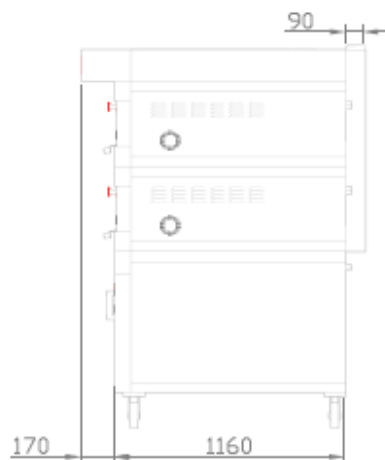
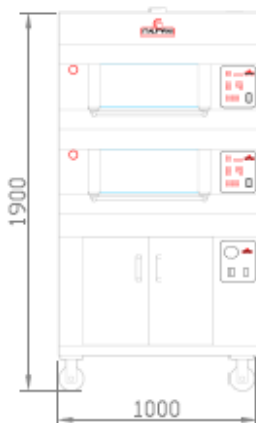

**ITALFORNI È UN BRAND  
 DI WAICO GROUP**

ITALFORNI - Sede operativa  
 Via dell'Industria, 130 - Loc. Chiusa di Ginestreto  
 61122 Pesaro (PU) Italia - Tel. +39 0721 481515  
 italforni@waicogroup.com - www.italforni.it

WAICO srl - Sede legale  
 Via Scotte, 1 - Isola Vicentina  
 36033 Vicenza (VI) Italia - Tel. +39 0445 1716598  
 info@waicogroup.com - www.waicogroup.com

**2 CAMERE PFD + STAND MEDIO**  
2 DECKS PFD + MID STAND

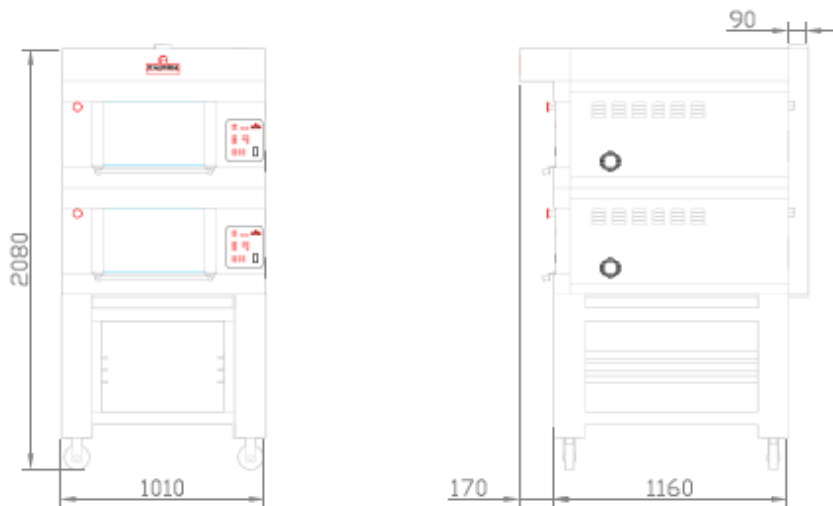

ALLACCIO ELETTRICO  
ELECTRIC CONNECTION



**2 CAMERE PFD + CELLA LIEVITAZIONE ALTA**  
2 DECKS PFD + HIGH PROVER

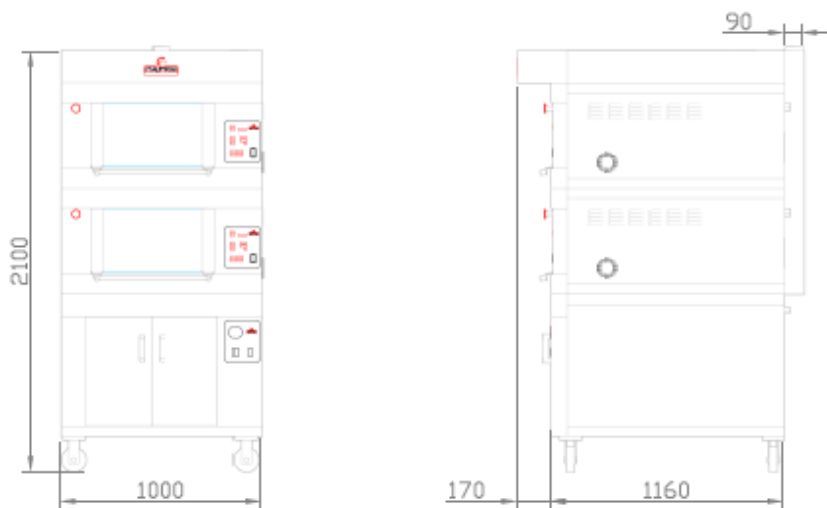

ALLACCIO ELETTRICO  
ELECTRIC CONNECTION

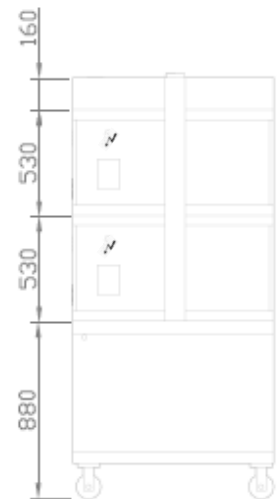

**2 CAMERE 1 PFA + 1 PFD + SUPPORTO MEDIO**  
2 DECKS 1 PFA + 1 PFD + MID STAND



ALLACCIO ELETTRICO  
ELECTRIC CONNECTION



ITALFORNI È UN BRAND  
DI WAICO GROUP

ITALFORNI - Sede operativa  
Via dell'Industria, 130 - Loc. Chiusa di Ginestreto  
61122 Pesaro (PU) Italia - Tel. +39 0721 481515  
italforni@waicogroup.com - www.italforni.it

WAICO srl - Sede legale  
Via Scotte, 1 - Isola Vicentina  
36033 Vicenza (VI) Italia - Tel. +39 0445 1716598  
info@waicogroup.com - www.waicogroup.com

**2 CAMERE 1 PFA + 1 PFD + CELLA DI LIEVITAZIONE ALTA**  
**2 DECKS 1 PFA + 1 PFD + HIGH PROVER**

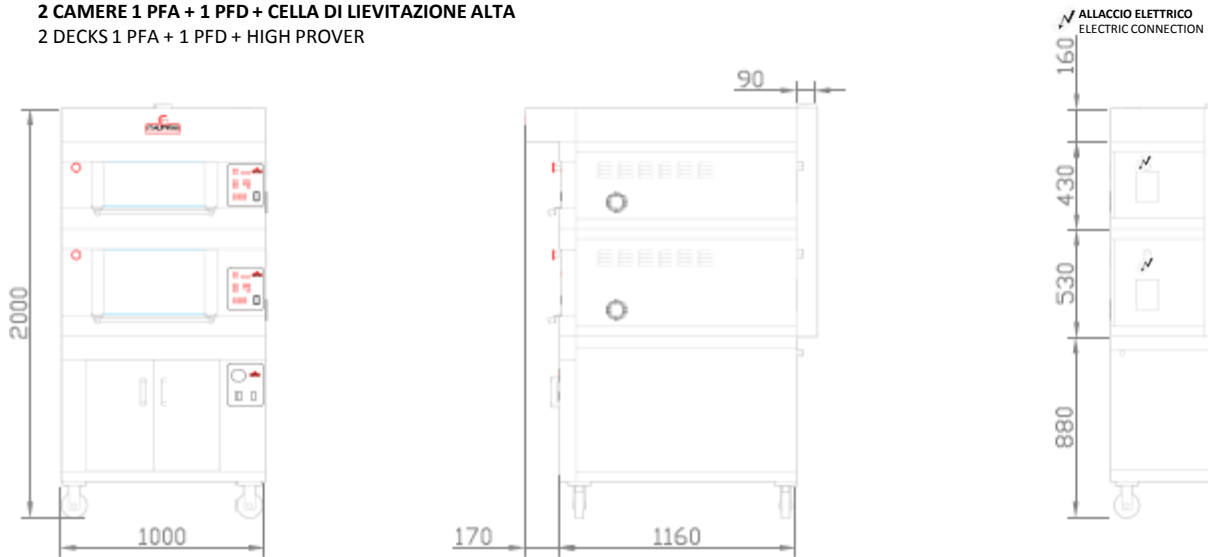

**3 CAMERE PFA + SUPPORTO BASSO**  
**3 DECKS PFA + LOW STAND**

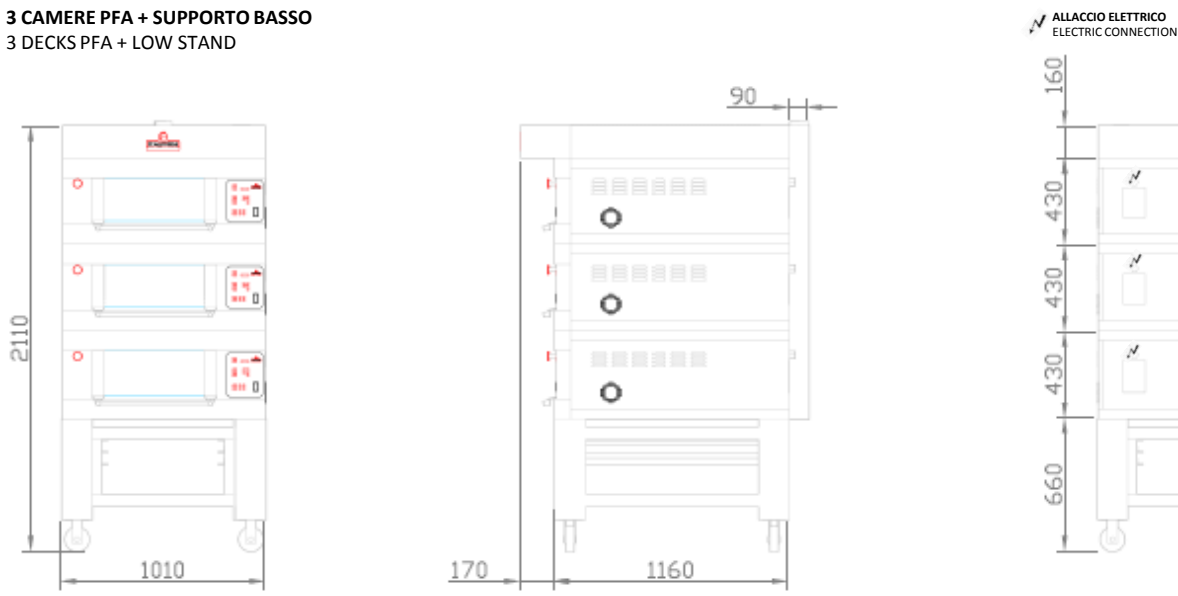

**3 CAMERE PFA + CELLA DI LIEVITAZIONE BASSA**  
**3 DECKS PFA + LOW PROVER**

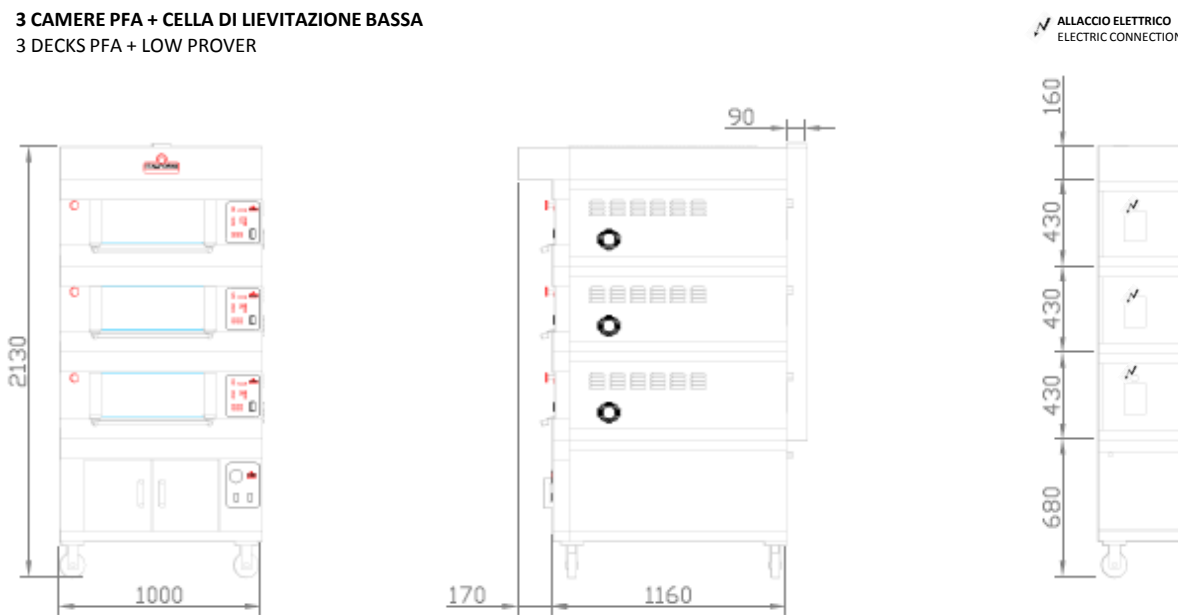

ITALFORNI È UN BRAND  
 DI WAICO GROUP

ITALFORNI - Sede operativa  
 Via dell'Industria, 130 - Loc. Chiusa di Ginestreto  
 61122 Pesaro (PU) Italia - Tel. +39 0721 481515  
 italforni@waicogroup.com - www.italforni.it

WAICO srl - Sede legale  
 Via Scotte, 1 - Isola Vicentina  
 36033 Vicenza (VI) Italia - Tel. +39 0445 1716598  
 info@waicogroup.com - www.waicogroup.com

**3 CAMERE 2 PFA + 1 PFD + STAND BASSO**  
**3 DECKS 2 PFA + 1 PFD + LOW STAND**

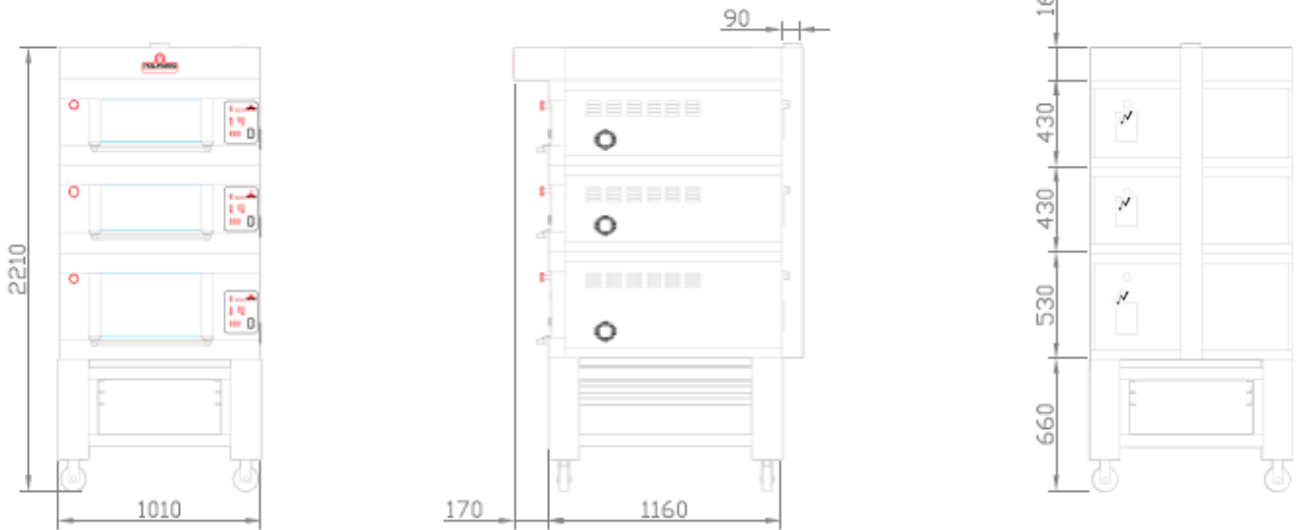

**3 CAMERE 2 PFA + 1 PFD + CELLA LIEVITAZIONE BASSA**  
**3 DECKS 2 PFA + 1 PFD + LOW PROVER**

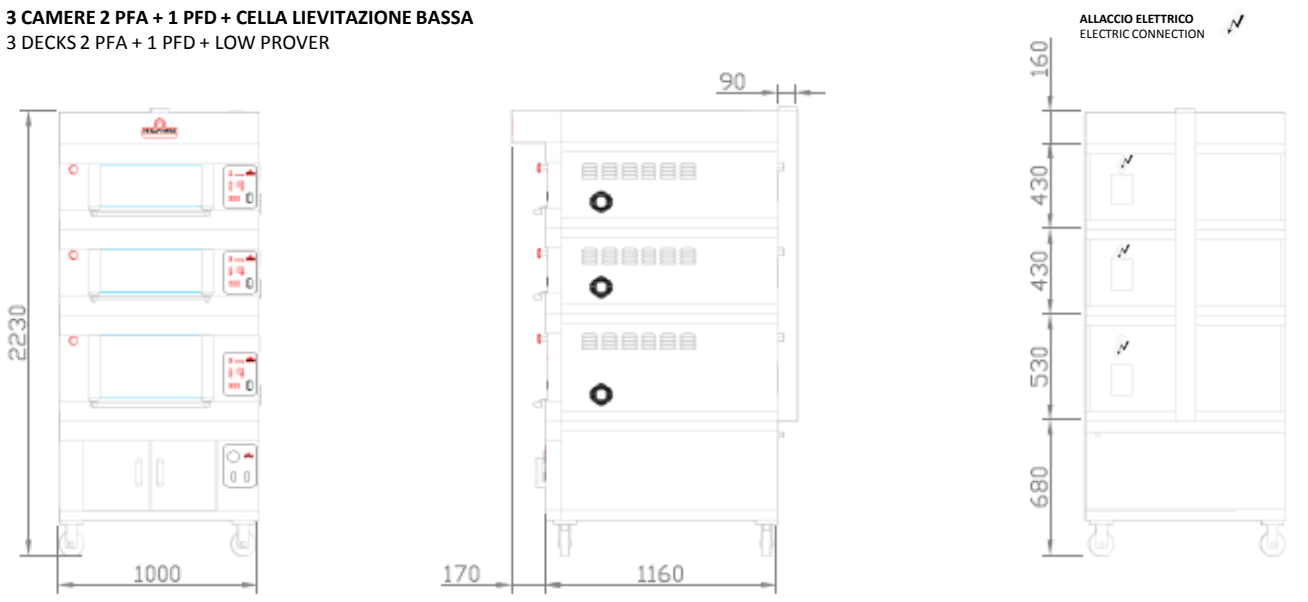

**ITALFORNI È UN BRAND  
 DI WAICO GROUP**

ITALFORNI - Sede operativa  
 Via dell'Industria, 130 - Loc. Chiusa di Ginestreto  
 61122 Pesaro (PU) Italia - Tel. +39 0721 481515  
 italforni@waicogroup.com - www.italforni.it

WAICO srl - Sede legale  
 Via Scotte, 1 - Isola Vicentina  
 36033 Vicenza (VI) Italia - Tel. +39 0445 1716598  
 info@waicogroup.com - www.waicogroup.com

**VALVOLA REGOLABILE PER SCARICO VAPORI**  
ADJUSTABLE STEAM EXHAUST VALVE

Vista dall'alto 1 camera  
Top view 1 deck

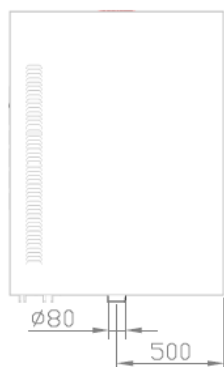

Vista dall'alto 2 o 3 camere  
Top view 2 or 3 decks



**VAPORIERA**  
STEAM INJECTION SYSTEM

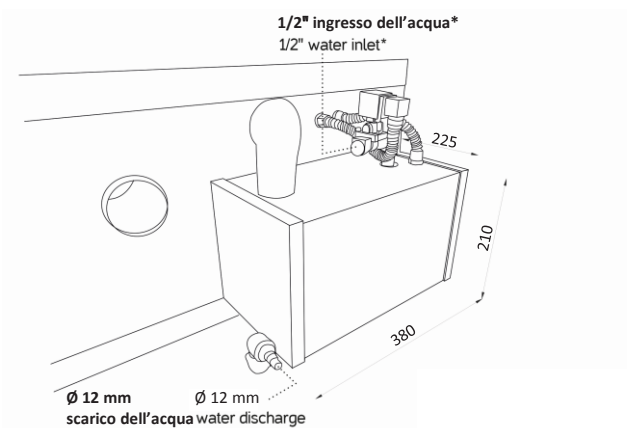

\*Deve essere installato un riduttore di pressione massima di 0.5/0.6 bar  
\*0.5/0.6 bar max pressure reduce has to be installed  
**Assorbimento massimo 1,4 Kw**  
Max. absorption 1,4 Kw

**CAPACITÀ DI CARICO PER CAMERA**  
LOADING CAPACITY PER DECK

PFA

DIMENSIONI INTERNE  
Internal dimensions  
A/H 17 x L/W 60 x P/D 80 cm  
2 Teglie 60x40 cm  
2 Baking pans 60x40 cm



PFD

DIMENSIONI INTERNE  
Internal dimensions  
A/H 27 x L/W 60 x P/D 80 cm  
2 Teglie 60x40 cm  
2 Baking pans 60x40 cm



**DATI TECNICI**  
TECHNICAL CHART



PastFood	Dimensioni interne (cm)			Dimensioni esterne (cm)			Peso	Alimentazione	Potenza	Potenza	Assorbimento	Temperatura	N° Teglie
	Internal dimensions (cm)			External dimensions (cm)			Weight	Supply	Power	Power	Absorption	Temperature	# Baking pans
	A/H	L/W	P/D	A/H	L/W	P/D	KG	V/Ph/Hz	KW	KW/h	Ampere	°C	60x40 cm
PFA - DECK	17	60	80	43	100	116	140	400/3/50-60	6,2	3,5	11	0/450	
PFD - DECK	27	60	80	53	100	116	170	400/3/50-60	6,2	3,5	11	0/450	
KPA/KPD - HOOD				16	100	133	28						
BPFA/BPFD - PROVER				70/50	100	116	75/60	230/1/50-60	1	0,5		0/90	14/8
SP 60/80 - STAND				86/70/50	101	116	46/42/36						18/12/6

ITALFORNI È UN BRAND  
DI WAICO GROUP

ITALFORNI - Sede operativa  
Via dell'Industria, 130 - Loc. Chiusa di Ginestreto  
61122 Pesaro (PU) Italia - Tel. +39 0721 481515  
italforni@waicogroup.com - www.italforni.it

WAICO srl - Sede legale  
Via Scotte, 1 - Isola Vicentina  
36033 Vicenza (VI) Italia - Tel. +39 0445 1716598  
info@waicogroup.com - www.waicogroup.com